



ER Indexable Cutter >>>

ERgo just say "ergo".

The Ergo is a new trademark of Nine9 for ER type indexable cutter. Better rigidity, quick change, excellent repeatability, tool length maintain, and pre-balanced.



▶ 3 Different Sizes Of Integrated ER Taper-Shank Cutter

- ER11 / ER16 / ER20



Concept >>>

- ▶ **An Integrated ER Taper-Shank Cutter, Eliminate Assembly Tolerance.**
- ▶ **A Clamping Force Gained From The 3 Parts Including Ergo Nut, High Strength Ergo Pin And ER Taper.**
- ▶ **Ergo Nut Drives The Pin To Push Ergo Holder**
Into ER Taper. It Is " A simple way to maximize clamping force "
 - Short tool length and quick change system for adapting on small working area.
 - Ideal solution for BT30, driven tools, tapping and turning center.
 - Increase tool life.
 - Easy and simple assembly.
- ▶ **Ergo Provide Customized Tooling Service.**



Applications

**Quick Change,
Saving Huge
Machine Downtime.**

- The simplest way to get tools on the machine.
- 3 fixed tool length groups of Ergo system.
- No need to reset tool length while changing tools in the same group.



“ The Ergo system includes milling cutter, spot drills, engraving tools, deburring tools, chamfering tools, and center drills. ”

OAL: 33.5mm Group
Tool Length Setter

Multi-Functional Tool

Engraving & Deburring







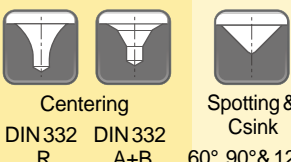
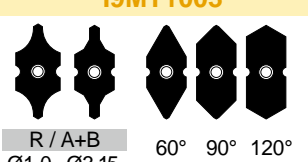
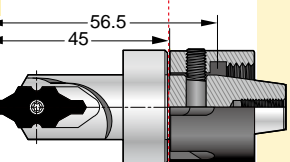
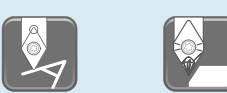

Chamfer Mill

OAL: 26mm Group
Power Mill $\varnothing 10 \sim \varnothing 32\text{mm}$

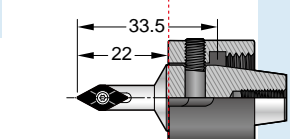
OAL: 56.5mm
i-Center

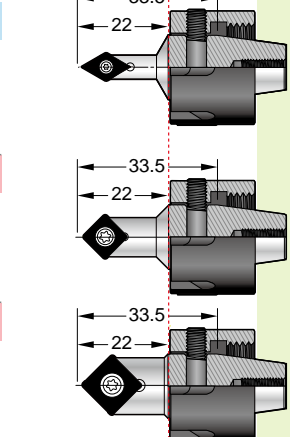
5

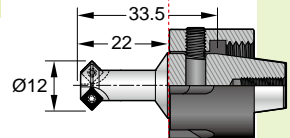
Ergo

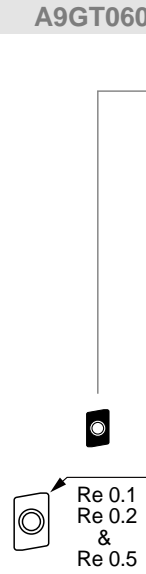
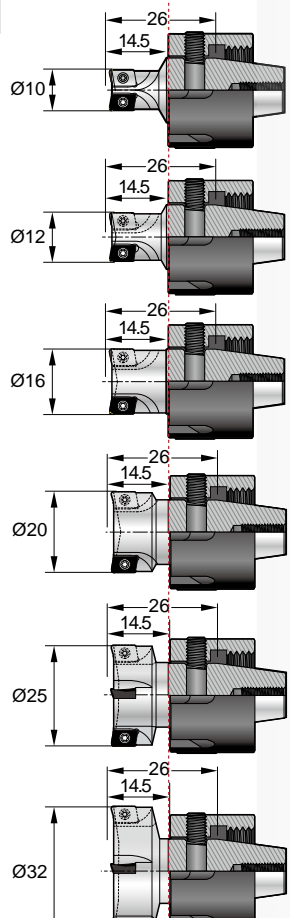
<p>ER16</p>	<p>i-Center Internal coolant G6.3 10,000 r.p.m.</p>	 <p>Centering DIN 332 R DIN 332 A+B</p> <p>Spotting & Csink 60°, 90° & 120°</p>	<p>I9MT1003</p>  <p>R / A+B 60° 90° 120° Ø1.0-Ø3.15</p>	
<p>ER16</p>	<p>X060 G4.0 20,000 r.p.m.</p>	 <p>Spotting/Engraving 30° ~ 142°</p> <p>Deburring 60° & 90°</p>	<p>X060</p>  <p>30° 45° 60° 90° 120° 142° 60° 90°</p>	
<p>ER16</p>	<p>Multi-Functional Tool G6.3 10,000 r.p.m.</p>	 <p>Spotting Chamfering</p>	<p>V060 60°</p> <p>N9MT0802 90°</p> <p>N9MT11T3 90°</p>	
<p>ER16</p>	<p>Chamfer Mill G6.3 10,000 r.p.m.</p>	 <p>Front & Back Chamfering Face Milling</p>	<p>N9GX04T002 45°</p>	
<p>ER11</p> <p>ER16</p> <p>ER20</p>	<p>Power Mill G6.3 10,000 r.p.m.</p>	 <p>Ø10 Ø32</p> <p>Smaller, sharper and more effective teeth.</p>	<p>A9GT0602</p>  <p>Re 0.1 Re 0.2 & Re 0.5</p>	

99816-IC10BH

OAL
||
56.5
mm

99816-X060

99816-V060

99816-610

99816-614

99816-C10

OAL
||
33.5
mm

99816-10A06

99816-12A06

99816-16A06

99816-20A06

99816-25A06

99816-32A06

OAL
||
26
mm

Center distance: 33mm
(ER16 M19)

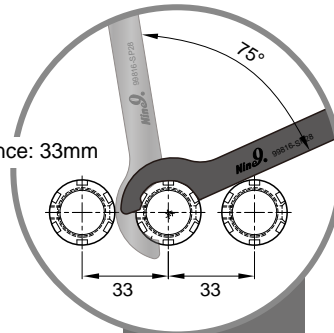

ER
11

ER
16

ER
20

Pin & Nut
are sold separately.

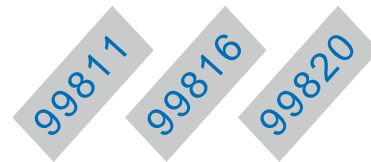
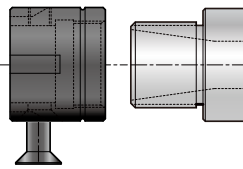

Ergo system can apply on live spindle tool of turning centers and swiss type automatic lathes, such as Star, Citizen, Doosan, Tsugami, Tornos, INDEX, EMAG...and so on. And also good for tapping and machining centers.

Center distance: 39mm
(ER16 M22)

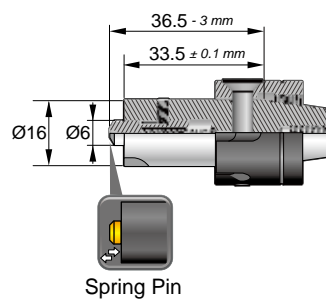
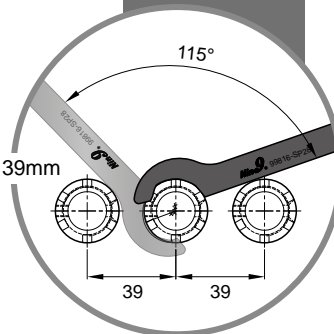

**Ergo
Setter TP**





99816-TP

refer to
Page 5-104

Ergo's Features

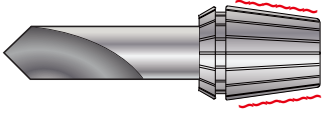

► Optimize the rigidity >>

- An integrated ER taper- shank cutter, eliminate assembly tolerance.
- Pre-balanced, ready for high speed machining. Increase tool life.

Ergo Integrated design	Cutting tool + Spring collet
  <ul style="list-style-type: none"> • Improve tool concentricity • Increase rigidity 	  <ul style="list-style-type: none"> • When tightening ER nut, be cautious of uneven tightening situation. • Chips, rust, or collet deform.



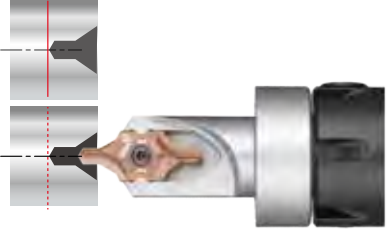
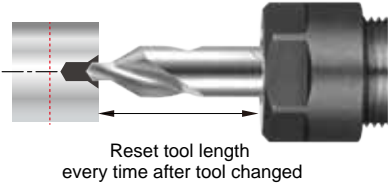

► Excellent repeatability, saving set-up time >>

- The greatest benefit is saving the tool changing time and tool length setting time.
- The drilling depth is constant after change the insert or cutting edge.

Ergo indexable cutter	Solid carbide center drill
 	 

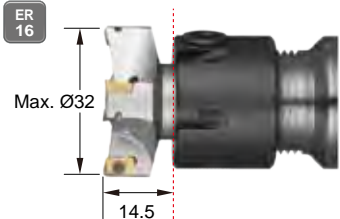

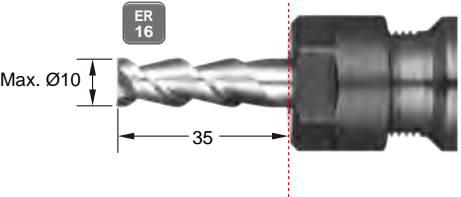
► Dimension is not limited by the ER16 collet clamping range >>

- Cover milling cutter range from $\varnothing 10$ to $\varnothing 32$ mm.
- More efficiency and the possibilities to cut bigger parts.
- The shorter tool length, the better run-out accuracy.

Ergo indexable cutter	Solid carbide end mill
 	 

► Easy and simple assembly >>

- A simple Ergo cutter has minimal assemble parts, saving 50% your time.
- Thanks to ER taper, the repeatability of assemble tolerance is ± 0.1 mm while changing same tool length of Ergo holder.

Ergo cutter	Solid carbide cutter
 	 

i-Center Indexable Center Drill

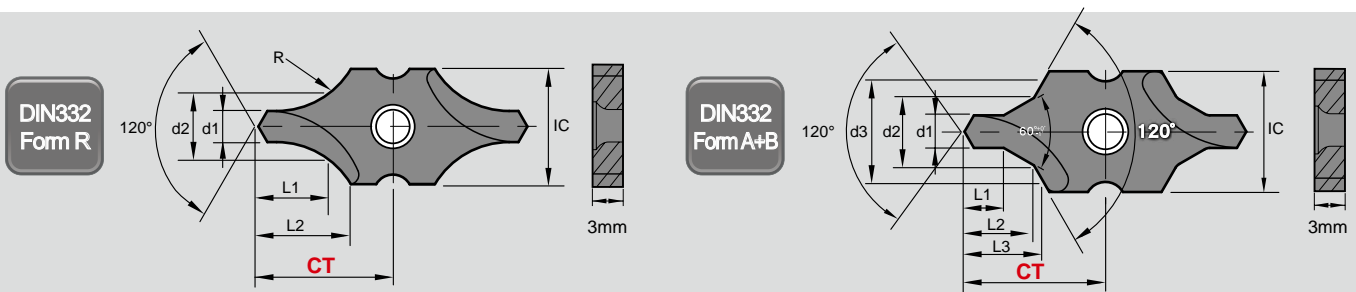

► For DIN332 Form R Center Hole >>

IC	Code	Parts No.	Coating	Grade	d1	d2	L1	L2	R	CT ±0.025	
10	031200	I9MT1003R0100-NC2057	AlTiN+TiSiN	P35	1.00	+0.14 0	2.12	2.16	4.72	2.8	12.35
	031201	I9MT1003R0125-NC2057			1.25		2.65	2.74	5.22	3.5	
	031202	I9MT1003R0150-NC2057			1.50		3.60	3.67	6.14	5.0	
	031203	I9MT1003R0160-NC2057			1.60		3.35	3.45	5.32	4.5	
	031204	I9MT1003R0200-NC2057			2.00	4.25	4.45	6.50	5.65		
	031205	I9MT1003R0250-NC2057			2.50	5.30	5.59	7.66	7.15		
	031206	I9MT1003R0300-NC2057			3.00	5.70	6.92	9.50	10.00		
	031207	I9MT1003R0315-NC2057			3.15	6.70	7.21	8.93	9.00		



► For DIN332 Form A+B Center Hole >>

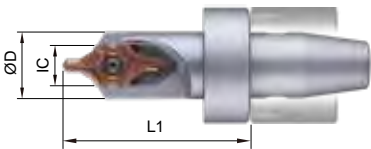

IC	Code	Parts No.	Coating	Grade	d1	d2	d3	L1	L2	L3	CT ±0.025	
10	031000	I9MT1003B0100-NC2057	AlTiN+TiSiN	P35	1.00	+0.14 0	2.12	3.15	1.3	2.21	2.51	12.35
	031001	I9MT1003B0125-NC2057			1.25		2.65	4.00	1.6	2.75	3.14	
	031002	I9MT1003B0150-NC2057			1.50		3.18	4.50	2.0	3.45	3.84	
	031003	I9MT1003B0160-NC2057			1.60		3.35	5.00	2.0	3.46	3.93	
	031004	I9MT1003B0200-NC2057			2.00	4.25	6.30	2.5	4.39	4.98		
	031005	I9MT1003B0250-NC2057			2.50	5.30	8.00	3.1	5.53	6.28		
	031006	I9MT1003B0300-NC2057			3.00	6.46	9.00	4.1	7.10	7.83		
	031007	I9MT1003B0315-NC2057			3.15	6.70	10.0	3.9	6.90	7.85		

► Basic Holder >> • G6.3 / 10,000 r.p.m. • With internal coolant.

IC	Code	Parts No.	Basic Holder	L1	øD	Screw	Key
10	16-801003	00-99816-IC10BH		16	45	*NS-25060/ 0.9Nm	NK-T7

*Torque screwdriver is recommended.

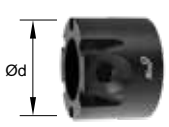
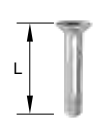
► Accessories - Set & Spare >>

Set	Ergo Nut			High Strength Ergo Pin			L-Key	Ergo Spanner		
 * Nut, pin & L-key are included.										
ER	Parts No.	Parts No.	Ød	Pitch	Torque	Parts No.	L	Torque	Parts No.	Parts No.
ER16	00-99816-M19S	00-99816-M19	25	M19xP1.0	30 Nm	NS-50025	25	5 Nm	NK-LW3	00-99816-SP28
	00-99816-M22S	00-99816-M22	28	M22xP1.5	30 Nm	NS-50028	28	5 Nm		

i-Center Spotting & Countersink

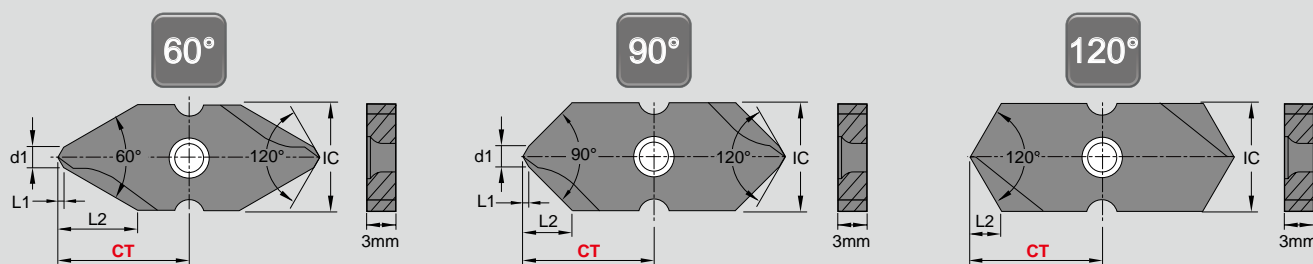

► Insert >>

- Double-edged cutting, fully ground insert for improving machining stability.
- NC2057: Universal grade for all kind of steel.
- Each insert has 2 cutting edges.

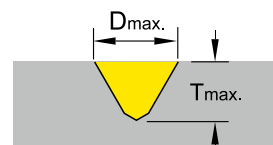

IC	Angle	Code	Parts No.	Coating	Grade	Dimensions			Dmax.	Tmax.	CT ±0.025
						d1	L1	L2			
10	60°	031401	I9MT1003CT060-NC2057	AlTiN+TiSiN	P35	2	0.58	7.5	10	7.5	12.35
	90°	031402	I9MT1003CT090-NC2057					4.6	10	4.6	
	120°	031403	I9MT1003CT120-NC2057			-	-	2.9	10	2.9	

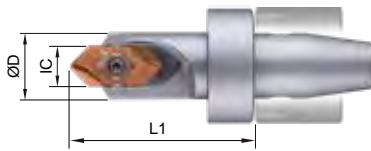

► Basic Holder >>

- G6.3 / 10,000 r.p.m.
- With internal coolant.

IC	Code	Parts No.	Basic Holder	L1	øD	Screw	Key
10	16-801003	00-99816-IC10BH		16	45	*S-25060 / 0.9Nm	NK-T7

*Torque screwdriver is recommended.

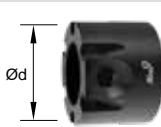
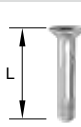
► Accessories - Set & Spare >>

Set		Ergo Nut				High Strength Ergo Pin			L-Key	Ergo Spanner
										
ER	Parts No.	Parts No.	Ød	Pitch	Torque	Parts No.	L	Torque	Parts No.	Parts No.
ER16	00-99816-M19S	00-99816-M19	25	M19xP1.0	30 Nm	NS-50025	25	5 Nm	NK-LW3	00-99816-SP28
	00-99816-M22S	00-99816-M22	28	M22xP1.5	30 Nm	NS-50028	28	5 Nm		

5

Ergo

i-Center Cutting Data

- Internal coolant is recommended.
- Middle value of feed rate is recommended for starting.
- Using your “d1” value and cutting speed Vc from the data sheet, calculate spindle speed “S”(r.p.m).
- “ F” feed rate per minute $F = S \times f = \text{IPR} \times \text{r.p.m.}$

► Indexable Center Drill >>

Workpiece Material	Vc (m/min.)		d1 (Pilot Diameter)									
			Ø1	Ø1.25	Ø1.50	Ø1.60	Ø2.0	Ø2.50	Ø3.0	Ø3.15		
P Carbon steel C<0.3%	< 80	S r.p.m.	2000	2000	1800	1600	1600	1400	1300	1200	●	○
		f mm/rev.	0.01	0.01	0.01	0.02	0.02	0.03	0.03	0.03		
	< 70	S r.p.m.	2000	2000	1800	1600	1600	1400	1300	1200	●	○
		f mm/rev.	0.01	0.01	0.01	0.02	0.02	0.03	0.03	0.03		
Low alloy steel C<0.3%	< 65	S r.p.m.	2000	2000	1800	1600	1600	1400	1300	1200	●	○
		f mm/rev.	0.01	0.01	0.01	0.01	0.01	0.02	0.02	0.03		
High alloy steel C>0.3%	< 60	S r.p.m.	1000	1000	900	800	800	700	600	600	●	○
		f mm/rev.	0.01	0.01	0.01	0.01	0.01	0.02	0.02	0.03		
M Stainless steel	< 20	S r.p.m.	1000	1000	900	800	800	700	600	600	●	○
		f mm/rev.	0.003	0.005	0.005	0.005	0.01	0.01	0.01	0.02		
N Al, and non-ferrous metal	< 200	S r.p.m.	6000	6000	5000	4800	4800	4200	4000	3600	●	○
		f mm/rev.	0.01	0.01	0.01	0.01	0.01	0.02	0.02	0.02		

● Best ○ Possible

5

Ergo

► Spotting & Countersink >>

Workpiece Material	Spotting				Countersink	
	Vc (m/min)	f (mm/rev.)			Vc (m/min)	f (mm/rev.)
		60°	90°	120°		
P Carbon steel C<0.3%	120 ~ 250	0.08 ~ 0.20	0.15 ~ 0.25	0.10 ~ 0.30	120 ~ 250	0.20 ~ 0.50
Carbon steel C>0.3%	100 ~ 220	0.08 ~ 0.20	0.10 ~ 0.05	0.10 ~ 0.30	100 ~ 220	0.20 ~ 0.40
Low alloy steel C<0.3%	100 ~ 200	0.06 ~ 0.16	0.08 ~ 0.20	0.10 ~ 0.25	100 ~ 200	0.15 ~ 0.40
High alloy steel C>0.3%	80 ~ 180	0.06 ~ 0.12	0.08 ~ 0.20	0.10 ~ 0.25	80 ~ 180	0.10 ~ 0.30
M Stainless steel	60 ~ 120	0.04 ~ 0.10	0.06 ~ 0.12	0.08 ~ 0.15	60 ~ 120	0.08 ~ 0.30
N Al, and non-ferrous metal	150 ~ 300	0.08 ~ 0.20	0.10 ~ 0.25	0.10 ~ 0.30	150 ~ 300	0.20 ~ 0.50

X060 Micro Spotting & Engraving



► Micro Spotting >>

- Radius Angled Form

Angle	Code	Parts No.	Coating	Grade		Dimensions			Wmin.	Wmax.	Tmax.	
						L	S	Re				
90°	01X0082	X060A90W010R	NC2032	TiAlN	K20F		6	2.05	0.02	0.10	1.10	0.5
	01X0220		XP9001	Uncoated								
120°	01X0222	X060A120W010R	NC2032	TiAlN	K20F		6	2.05	0.02	0.10	2.53	0.7
142	01X0223	X060A142W010R	NC2032	TiAlN	K20F		6	2.05	0.02	0.10	2.42	0.4

► Engraving >>

- Radius Angled Form

Angle	Code	Parts No.	Coating	Grade		Dimensions			Wmin.	Wmax.	Tmax.	
						L	S	Re				
30°	01X0140	X060A30W020R	NC2032	TiAlN	K20F		6	2.05	0.04	0.20	0.52	0.6
	01X0142		XP9001	Uncoated								
45°	01X0021	X060A45W020R	NC2032	TiAlN	K20F		6	2.05	0.04	0.20	0.86	0.8
	01X0154		XP9001	Uncoated								
60°	01X0063	X060A60W020R	NC2032	TiAlN	K20F		6	2.05	0.04	0.20	1.36	1.0
	01X0166		XP9001	Uncoated								
90°	01X0207	X060A90W020R	NC2032	TiAlN	K20F		6	2.05	0.04	0.20	2.20	1.0
	01X0209		XP9001	Uncoated								

- Radius Form

Angle	Code	Parts No.	Coating	Grade		Dimensions			Wmin.	Wmax.	Tmax.	
						L	S	Re				
30°	01X0119	X060A30R020	NC2032	TiAlN	K20F		6	2.05	0.2	0.15	0.63	0.6
	01X0134		XP9001	Uncoated								
45°	01X0013	X060A45R020	NC2032	TiAlN	K20F		6	2.05	0.2	0.12	0.93	0.8
	01X0150		XP9001	Uncoated								
60°	01X0117	X060A60R020	NC2032	TiAlN	K20F		6	2.05	0.2	0.10	1.39	1.0
	01X0159		XP9001	Uncoated								

► More & Cutting Data >>

- For more micro spotting insert & cutting data, please refer to page 2-19.
- For more engraving insert & cutting data, please refer from page 3-65.

X060 Deburring



► Deburring >>

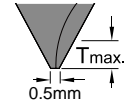

Angle	Code	Part No.	Coating	Grade	Flutes	Diagram	Dimensions		Tmin.	Tmax.
							L	S		
60°	01X611	X060A60T3-NC2032	TiAlN	K20F	3		6	2.8	0.1	0.9
	01X612	X060A60T3-XP9001	Uncoated							
90°	01X911	X060A90T3-NC2032	TiAlN	K20F	3		6	2.8	0.1	0.9
	01X912	X060A90T3-XP9001	Uncoated							
60°	01X601	X060A60T6-NC2032	TiAlN	K20F	6		6	2.0	0.1	1.8
90°	01X901	X060A90T6-NC2032							0.5	1.5

► Basic Holder >>

- For entire X060 engraving, spotting and deburring inserts.
- G4.0 / 20,000 r.p.m.

Code	Parts No.	Basic Holder	L1	Screw	Key
16-69X004	00-99816-X060		22	*NS-22044 0.9Nm	NK-T7

*Torque screwdriver is recommended.

► Accessories - Set & Spare >>

Set		Ergo Nut				High Strength Ergo Pin			L-Key	Ergo Spanner
ER	Parts No.	Parts No.	Ød	Pitch	Torque	Parts No.	L	Torque	Parts No.	Parts No.
ER16	00-99816-M19S	00-99816-M19	25	M19xP1.0	30 Nm	NS-50025	25	5 Nm	NK-LW3	00-99816-SP28
	00-99816-M22S	00-99816-M22	28	M22xP1.5	30 Nm	NS-50028	28	5 Nm		

► Cutting Data >>

- For Deburring, please refer to page 4-79.

Multi-Functional Tool Spotting & Chamfering



► Inserts >>

Angle	Code	Parts No.	Coating	Grade	Diagram	Dimensions			Dmax.	Tmax.
						L	S	Re		
60°	0106001	V06006T1W06-NC2071	TiN	K20F		6.35	2.0	0.2	2.7	2.0
	0106002	V06006T1W06-NC2032	TiAlN							
	0106004	V06006T1W06-NC9031	TiN							
90°	013401	N9MT080208CT-NC40	TiN	K20F		8.31	2.38	0.8	10	4.5
	013402	N9MT080204CT-NC40	TiN					0.4		
	013403	N9MT080204CT-NC10	TiAlN					0.4		
90°	014401	N9MT11T3CT-NC40	TiN	P35		11.11	3.97	0.8	14	7
	014402	N9MT11T3CT-NC10	TiAlN					K10F		

► Basic Holder >>

• G6.3 / 10,000 r.p.m.

Code	Parts No.	Basic Holder	Insert Type	L1	Screw	Key
16-692005	00-99816-V060		V060...		*NS-22044 0.9Nm	NK-T7
16-603004	00-99816-610		N9MT0802...	22	NS-30055 2.0 Nm	NK-T8
16-604010	00-99816-614		N9MT11T3...		NS-35080 2.5 Nm	NK-T15

*Torque screwdriver is recommended.

► Accessories - Set & Spare >>

Set		Ergo Nut				High Strength Ergo Pin			L-Key	Ergo Spanner
ER	Parts No.	Parts No.	Ød	Pitch	Torque	Parts No.	L	Torque	Parts No.	Parts No.
ER16	00-99816-M19S	00-99816-M19	25	M19xP1.0	30 Nm	NS-50025	25	5 Nm	NK-LW3	00-99816-SP28
	00-99816-M22S	00-99816-M22	28	M22xP1.5	30 Nm	NS-50028	28	5 Nm		

► Cutting Data >> please refer to page 3-76 for 60° insert, page 2-45 for 90° insert.

45° Chamfer Mill

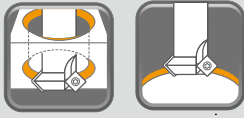

► Inserts >>

Code	Parts No.	Coating	Grade		Dimensions			
					L	S	Re	
021401	N9GX04T002	NC2032	AlTiN	K20F		4.0	1.8	0.2
021402		NC9071	TiN					

► Basic Holder >>

- For front and back chamfering.
- G6.3 / 10,000 r.p.m.

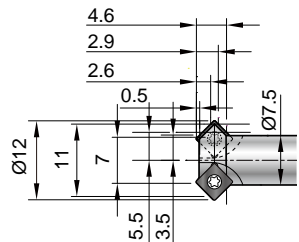
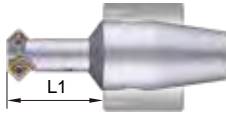

Code	Parts No.	Basic Holder	L1	No. of teeth	Screw	Key
16-701003	00-99816-C10			22	2	*NS-18037 NK-T6 0.6Nm

*Torque screwdriver is recommended.

5

Ergo

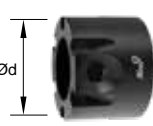
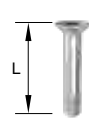
► Accessories - Set & Spare >>

Set		Ergo Nut				High Strength Ergo Pin			L-Key	Ergo Spanner
	* Nut, pin & L-key are included.		Ød				L			
ER	Parts No.	Parts No.	Ød	Pitch	Torque	Parts No.	L	Torque	Parts No.	Parts No.
ER16	00-99816-M19S	00-99816-M19	25	M19xP1.0	30 Nm	NS-50025	25	5 Nm	NK-LW3	00-99816-SP28
	00-99816-M22S	00-99816-M22	28	M22xP1.5	30 Nm	NS-50028	28	5 Nm		

► Cutting Data >> please refer to page 4-89.

Power Mill



▶ Inserts >>

- U type insert is fully ground for reducing the cutting resistance during the cutting, best choice for long shank cutter.
- H type with high positive rake angle, shape edge.

Code	Parts No.		Coating	Grade	Insert	Dimensions				
						Re	Ap	L	W	S
05A122	A9GT060201H	NC2033	TiAlN	K20F		0.1	5	6.5	4	2.45
05A123		NC9031	TiN							
05A132	A9GT060202H	NC2033	TiAlN	K20F		0.2				
05A133		NC9031	TiN							
05A102	A9GT060205H	NC2033	TiAlN	K20F		0.5				
05A103		NC9031	TiN							
05A142	A9GT060201U	NC2032	TiAlN	K20F		0.1				
05A143	A9GT060202U	NC2032	TiAlN	K20F		0.2				
05A144	A9GT060205U	NC2032	TiAlN	K20F		0.5				

▶ Basic Holder >>

- G6.3 / 10,000 r.p.m.
- Customized cutter is available on request. Please refer to page 5-107.



ER Taper	Code	Parts No.	ØD	Basic Holder	L1	No. of teeth	α°	Screw / Key	
ER11	11-51A100	00-99811-10A06	10		14	2	5	*NS-18037 0.6Nm / NK-T6	
	11-51A122	00-99811-12A06	12			2	4		
ER16 (with internal coolant)	16-51A100	00-99816-10A06	10			14.5	2		5
	16-51A122	00-99816-12A06	12				2		4
	16-51A130	00-99816-16A06	16				3		2
	16-51A140	00-99816-20A06	20				3		2
	16-51A150	00-99816-25A06	25	4			1.3		
	16-51A160	00-99816-32A06	32	4			1		
ER20	20-51A122	00-99820-12A06	12		26	2	4		
	20-51A130	00-99820-16A06	16			3	2		
	20-51A140	00-99820-20A06	20			3	2		
	20-51A150	00-99820-25A06	25			4	1.3		
ER16	16-51A101	00-99816-10A06-32L	10		32	2	5		
	16-51A102	00-99816-10A06-40L	10			2	5		
ER20	20-51A101	00-99820-10A06-40L	10		40	2	5		
	20-51A124	00-99820-12A06-40L	12			2	4		

*Torque screwdriver is recommended.

5

Ergo

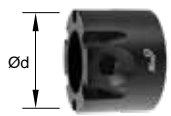
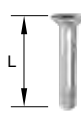
► Accessories - Set & Spare >>



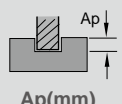
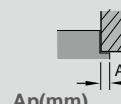

Set		Ergo Nut				High Strength Ergo Pin			L-Key	Ergo Spanner
										
ER	Parts No.	Parts No.	Ød	Pitch	Torque	Parts No.	L	Torque	Parts No.	Parts No.
ER11	00-99811-M13S	00-99811-M13	19	M13xP0.75	12 Nm	NS-40019	19	3 Nm	NK-LW25	00-99811-SP20
ER16	00-99816-M19S	00-99816-M19	25	M19xP1.0	30 Nm	NS-50025	25	5 Nm	NK-LW3	00-99816-SP28
	00-99816-M22S	00-99816-M22	28	M22xP1.5	30 Nm	NS-50028	28	5 Nm		
ER20	00-99820-M24S	00-99820-M24	34	M24xP1.0	45 Nm	NS-60033	33	6 Nm	NK-LW4	00-99820-SP36
	00-99820-M25S	00-99820-M25	34	M25xP1.5	45 Nm	NS-60033	33	6 Nm		

► Cutting Data >>

Workpiece Material	Vc (m/min)	fz (mm/tooth)			Grade of insert
Carbon Steel	80 ~ 150	0.03 ~ 0.07	1.5	3	1
P Low-alloy Steel C ≤ 0.3%					
High-alloy Steel C > 0.3%	60 ~ 120	0.02 ~ 0.06	1.0	2.5	1
M Stainless Steel	60 ~ 120	0.01 ~ 0.05	0.5	2.0	1
N Al, and non-ferrous metal (Cu)	200 ~ 500	0.02 ~ 0.07	2.0	4.0	2

► Performance >>

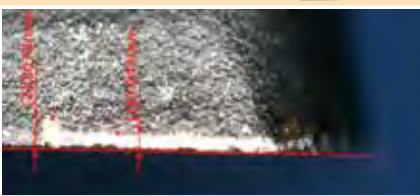
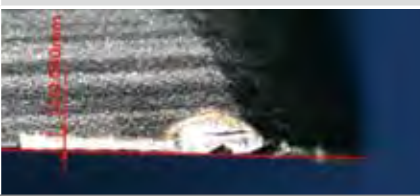
- Result - Surface Quality

Ergo power mill Ø10	Indexable milling cutter Ø10	Carbide end mill Ø10
		
		
VB=0.04 mm No chipping 😊	VB=0.04 mm Partial chipping 😞	VB=0.20 mm Extensive chipping 😞

- Measure VB value (tool wearing) and chipping condition

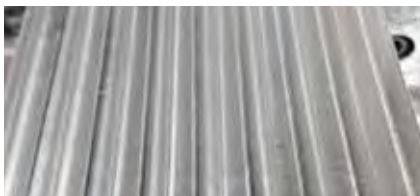
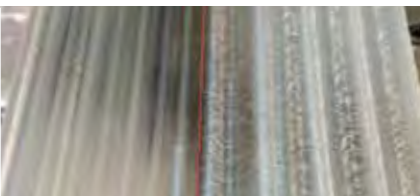
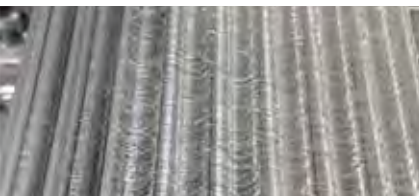
		
Surface finishing is fine 😊	About 50% surface finishing is rough 😞	About 80% surface finishing is rough 😞

5

Ergo

Ergo Setter TP



▶ Quick and simple tool length setting >>

▶ Tool length setter >>

- Ergo setter is an easy tool length recorder while setting the tool length on swiss type automatic lathe and CNC turning centers.
- Reduce machine downtime, prevent insert and workpiece from damage.

Code	Parts No.	Illustration	L-Key
16-TP0001	00-99816-TP		NK-LW15 (2 Nm)

▶ Accessories - Set & Spare >>

Set		Ergo Nut				High Strength Ergo Pin			L-Key	Ergo Spanner
	* Nut, pin & L-key are included.									
ER	Parts No.	Parts No.	Ød	Pitch	Torque	Parts No.	L	Torque	Parts No.	Parts No.
ER16	00-99816-M19S	00-99816-M19	25	M19xP1.0	30 Nm	NS-50025	25	5 Nm	NK-LW3	00-99816-SP28
	00-99816-M22S	00-99816-M22	28	M22xP1.5	30 Nm	NS-50028	28	5 Nm		

▶ Setting process >>

• Step-1

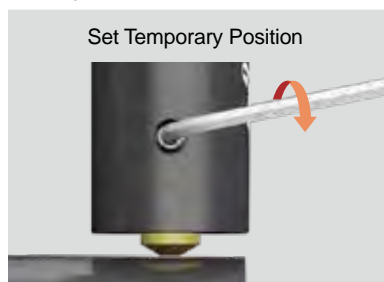

- 1-1: Move the setter tip to touch the center-top of workpiece.
- 1-2: Press spring pin 1~2 mm down.
- 1-3: Tighten screw to fix spring pin, and get a temporary length of setter.
- 1-4: Input the temporary length value to the CNC controller.

• Step-2

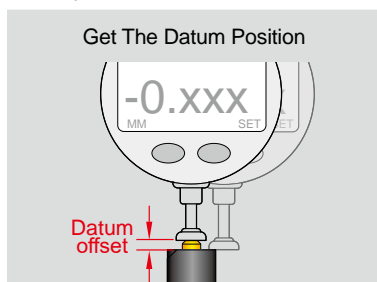

- 2-1: The offline measures the datum offset of setter by height gauge.
- 2-2: Input datum offset to CNC controller.

• Step-3

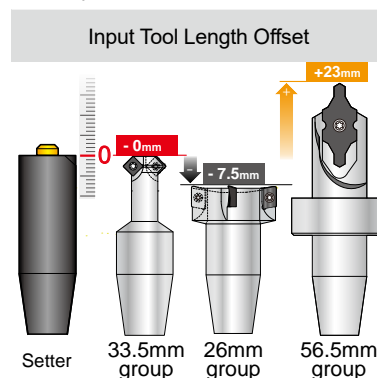

- 3-1: Choose an Ergo tool to install, and input the offset value to CNC controller directly.

Assembly Steps

! Make sure all parts are clean while re-assembly or change tool

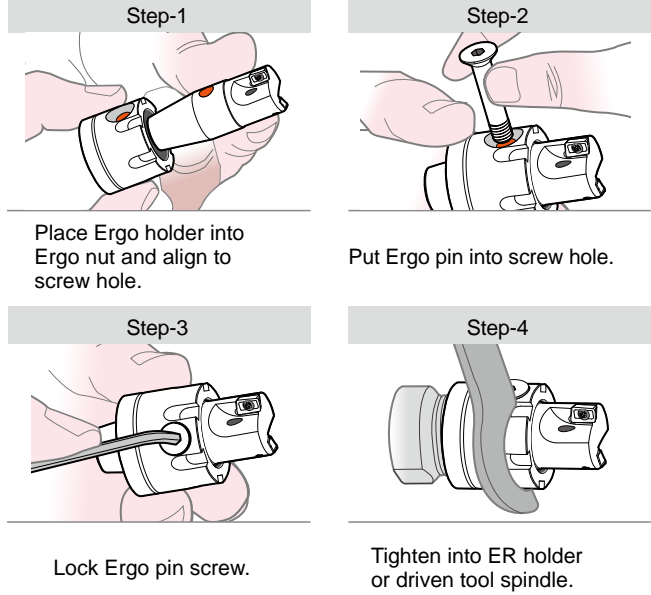
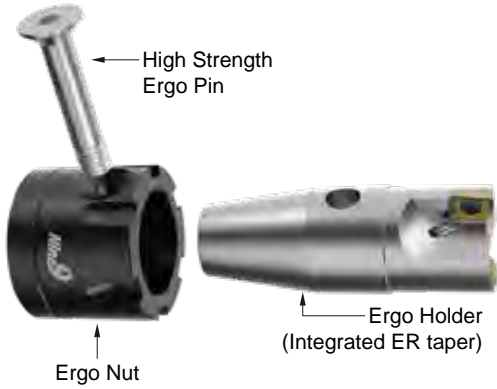

► As long as it complies with ER11, 16, 20 and ER25 standard, you can use Ergo system. >>



- Quick change and ultrashort over all tool length.
- Apply on any kinds of driven tools and collet chucks.

5

Ergo

► Performance >>

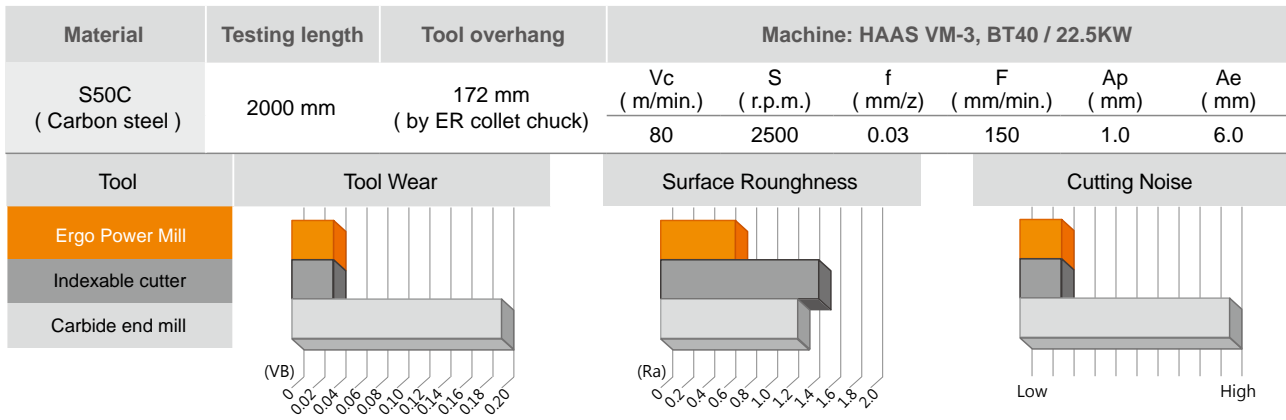

Ergo Sets For your first ordering

► The insert is not included >>

Nut	Series	Code	Parts No.	Contents
With ER16 Mini Nut (M19 x 1.0 P)	i-Center	161-801003	00-99816-IC10BH-M19S	 <p>Ergo Holder x1 Ergo ER16 Mini Nut x1 High Strength Ergo pin x1 3mm L key x1 Insert Key x1</p> <p>* The insert is not included.</p>
	X060 - Micro Spotting, Engraving & Deburring	161-69X004	00-99816-X060-M19S	
	Multi-Functional Tool - Spotting & Chamfering	161-692005	00-99816-V060-M19S	
		161-603004	00-99816-610-M19S	
		161-604010	00-99816-614-M19S	
	Chamfer Mills	161-701003	00-99816-C10-M19S	
		Power Mills	161-51A100	
	161-51A122		00-99816-12A06-M19S	
	161-51A130		00-99816-16A06-M19S	
	161-51A140		00-99816-20A06-M19S	
	161-51A150		00-99816-25A06-M19S	
	161-51A160		00-99816-32A06-M19S	
	Tool Length Setter	161-TP0001	00-99816-TP-M19S	
	With ER16 Nut (M22 x 1.5 P)	i-Center	162-801003	
X060 - Micro Spotting, Engraving & Deburring		162-69X004	00-99816-X060-M22S	
Multi-Functional Tool - Spotting & Chamfering		162-692005	00-99816-V060-M22S	
		162-603004	00-99816-610-M22S	
		162-604010	00-99816-614-M22S	
Chamfer Mills		162-701003	00-99816-C10-M22S	
		Power Mills	162-51A100	00-99816-10A06-M22S
162-51A122			00-99816-12A06-M22S	
162-51A130			00-99816-16A06-M22S	
162-51A140			00-99816-20A06-M22S	
162-51A150			00-99816-25A06-M22S	
162-51A160			00-99816-32A06-M22S	
Tool Length Setter		162-TP0001	00-99816-TP-M22S	

5

Ergo

Enquiry Form

► **Company >>**

► **Challenge or improvement >>**

• The following information should be checked while discussing with customer.

Machine		Current tool	
Machine Type		Cutting Speed	<input type="checkbox"/> HSS
Spindle Speed	Max. r.p.m.		<input type="checkbox"/> Solid Carbide
Power of Spindle motor	<input type="checkbox"/> KW <input type="checkbox"/> HP		m/min. SFM
Coolant supply	<input type="checkbox"/> NO	Others	
	<input type="checkbox"/> If yes, <input type="checkbox"/> External <input type="checkbox"/> Internal		
Workpiece Material	bar(psi)	Feed Rate	mm/rev. inch/rev.

► **ER Taper-shank dimensions >>**

• MOQ: 2 pcs / Lead Time: 10 ~ 12 Weeks.

Style		
<input type="checkbox"/> A	<input type="checkbox"/> B	<input type="checkbox"/> C

Cutter Dia. : ($\varnothing D_c$)		
L1 : (See chart for Max.)	θ : E :	
Internal Coolant	<input type="checkbox"/> Yes <input type="checkbox"/> No	
ER Nut	<input type="checkbox"/> N9ER16-M19 <input type="checkbox"/> N9ER16-M22 <input type="checkbox"/> N9ER20-M24 <input type="checkbox"/> N9ER20-M25 <input type="checkbox"/> N9ER25-M32	
Nut Specifications	M	
	<input type="checkbox"/> ER16	M19xP1.0
	<input type="checkbox"/> ER16	M22xP1.5
	<input type="checkbox"/> ER20	M24xP1.0
	<input type="checkbox"/> ER20	M25xP1.5
	<input type="checkbox"/> ER25	M32xP1.5

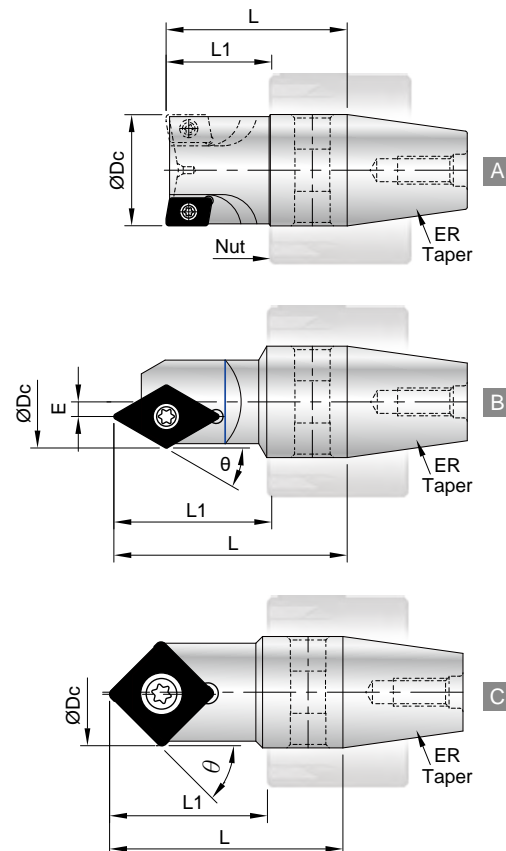
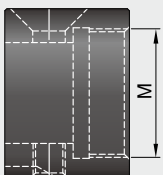

ER Taper Specifications			
$\varnothing D_c$	L1 Max.	L Max.	ER Taper
10 ~ 32	22	34	ER16
	26.5	40	ER20
	30.5	50	ER25

5

Ergo